



STANLEYS BARN

RESTAURANT & BAR

KIDS MENU

All kids meals come with Vanilla ice cream, Toppings
Chocolate, strawberry or caramel.

Spaghetti bolognese, parmesan cheese \$15

Crispy battered fish and chips \$15

Grilled minute steak w shoestring chips \$15

Chicken tenders w shoestring chips \$15

Milkshakes:

- Banana \$6
- Vanilla \$6
- Chocolate \$6
- Strawberry \$6

softdrinks:

- Coke \$4
- Coke (no sugar) \$4
- Lemonade \$4
- Solo \$4

Juices:

- Pineapple \$4
- Orange \$4
- Cloudy Apple \$4
- Cranberry \$4

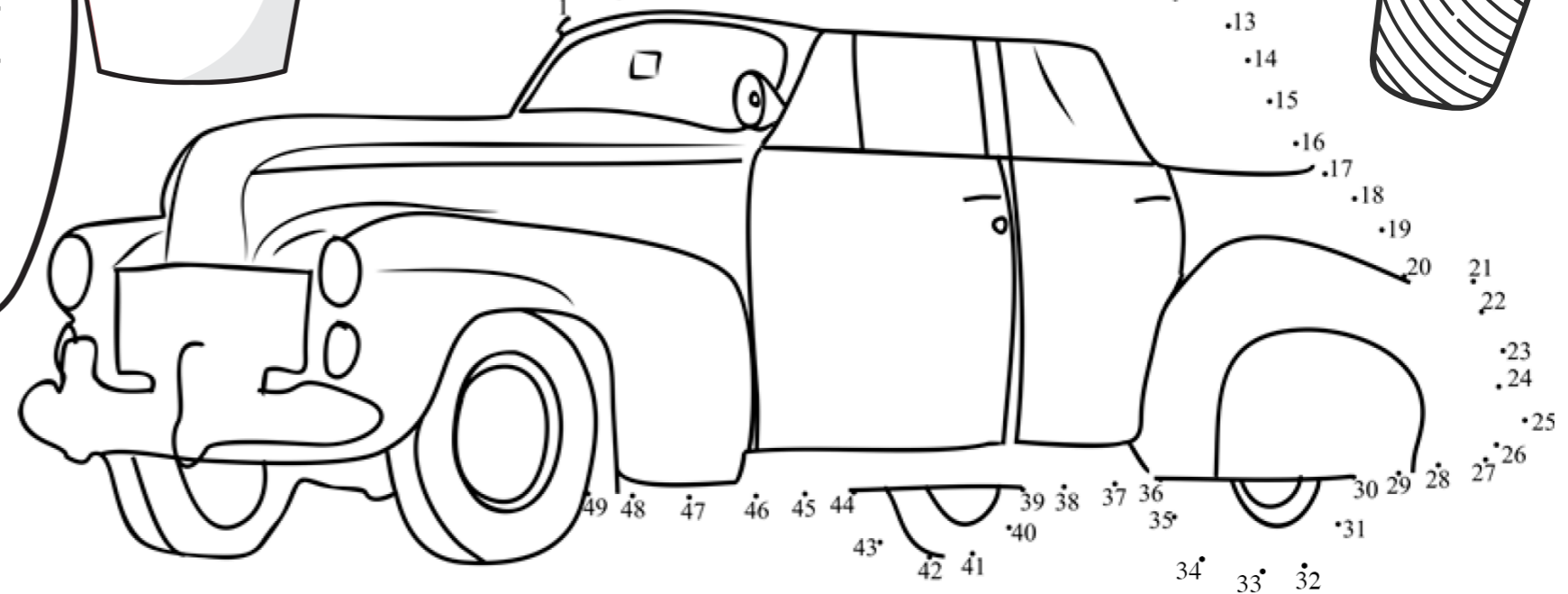
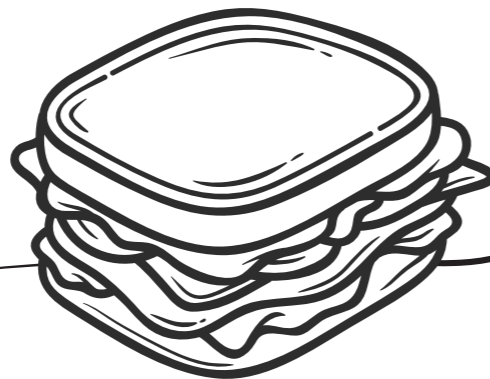
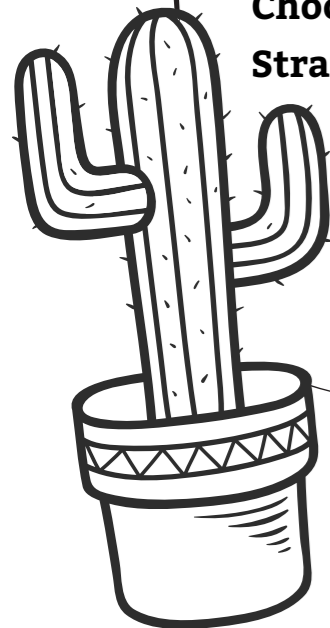

START

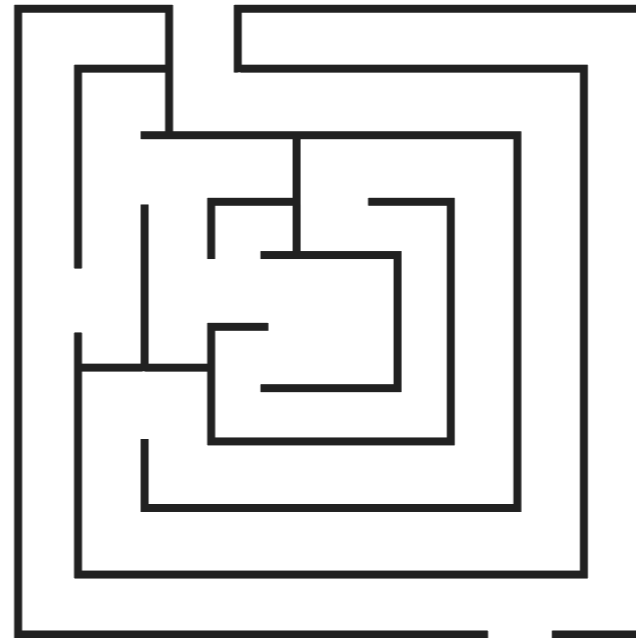

FINISH

FIND THE HIDDEN WORDS

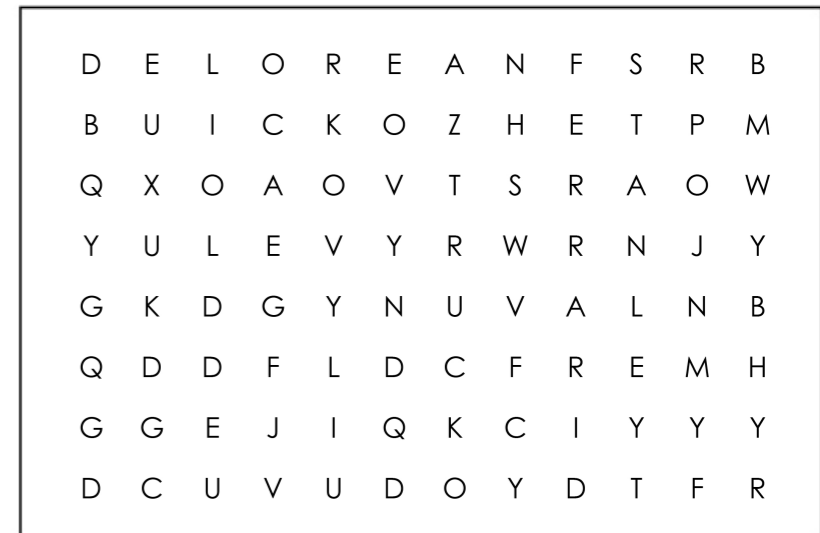

Find the following words in the puzzle.
Words are hidden → and ↓ .

BMW
BUICK
DELOREAN

FERRARI
OLD
STANLEY

TRUCK





STANLEYS BARN

RESTAURANT & BAR

KIDS MENU

- Scrambled eggs, Bacon and Toast** **\$10**
- Waffles, Ice Cream, Maple syrup** **\$10**
- Extra Hash Brown** **\$3**
- Extra bacon** **\$4**

Smoothies

- Banana Smoothie 9.00**
- Berry Dream 9.00**
- Mango Smoothie 9.00**
- The Green Hornet 9.00**

Milkshakes:

- Banana** **\$6**
- Vanilla** **\$6**
- Chocolate** **\$6**
- Strawberry** **\$6**

Softdrinks:

- Coke** **\$4**
- Coke (no sugar)** **\$4**
- Lemonade** **\$4**
- Solo** **\$4**

Juices:

- Pineapple** **\$4**
- Orange** **\$4**
- Cloudy Apple** **\$4**
- Cranberry** **\$4**

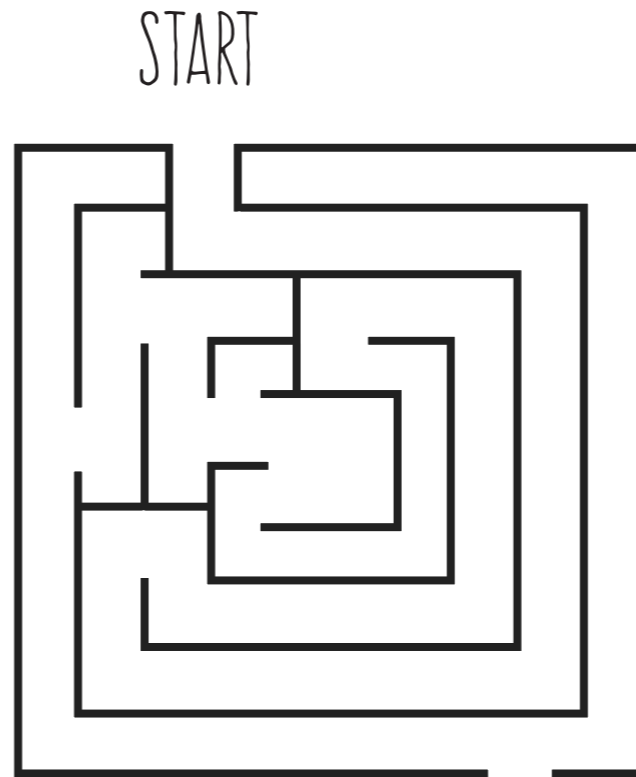

FIND THE HIDDEN WORDS

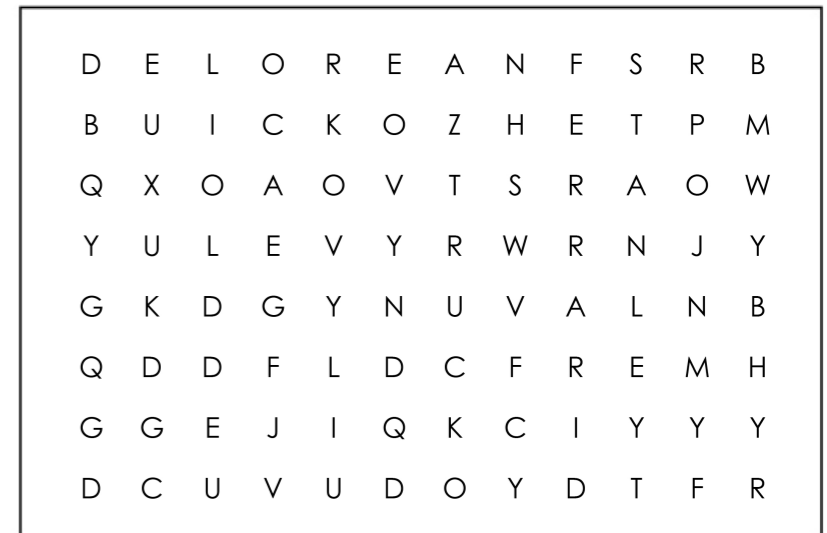

Find the following words in the puzzle.
Words are hidden → and ↓ .

BMW
BUICK
DELOREAN

FERRARI
OLD
STANLEY

TRUCK

